

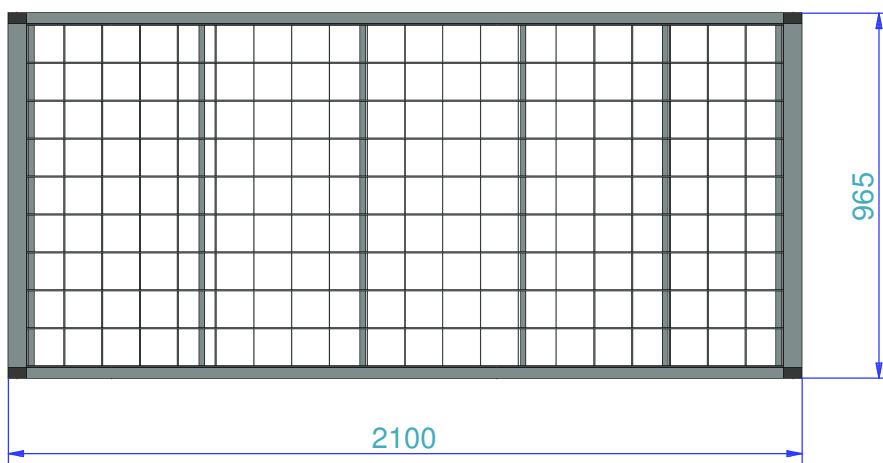

**RIEL**

**METALLBAU**

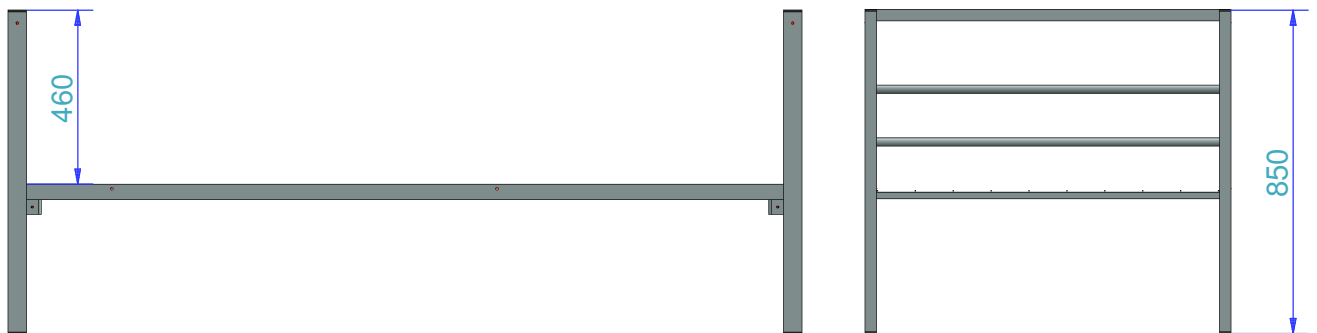
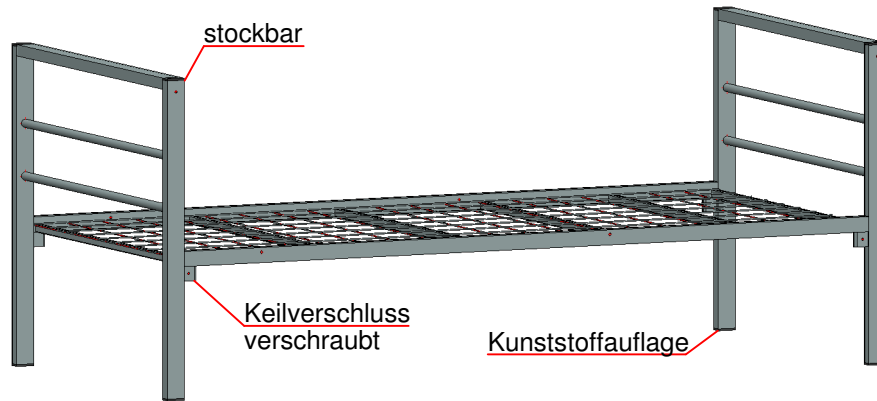

www.riel-metallbau.at

Zubehör

**Matratze:**

Schaumstoffkernmatratze  
200cm x 90cm 1-lagig  
oder 2-lagig

**Anbaunachttisch:**

L = 350  
B = 315  
H = 123



**Absturzsicherung:**

L = 1050 / H = 365

**Leiter:**

B = 365  
H = 863



Bezeichnung

**Einzelbett E200L stockbar**

Maßstab

**1 : 20**

Blatt-Nr.

**1 / 15**

Datum

**20.04.2016**

**RAL 5010**

**RAL 6017**

**RAL 7001**

**RAL 8017**

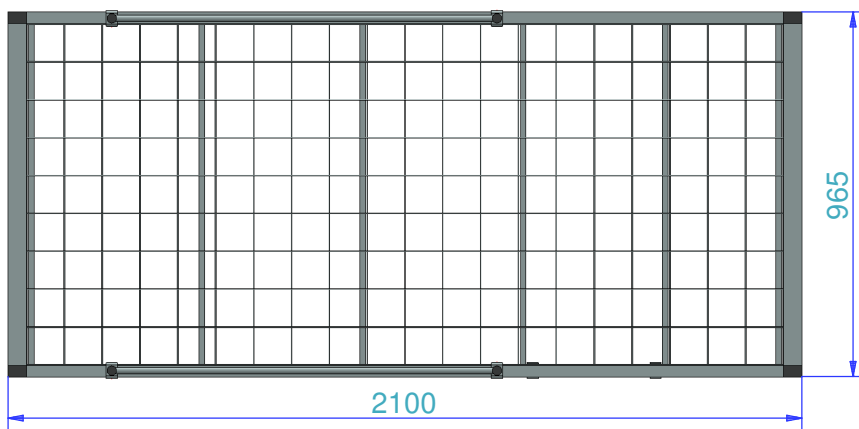
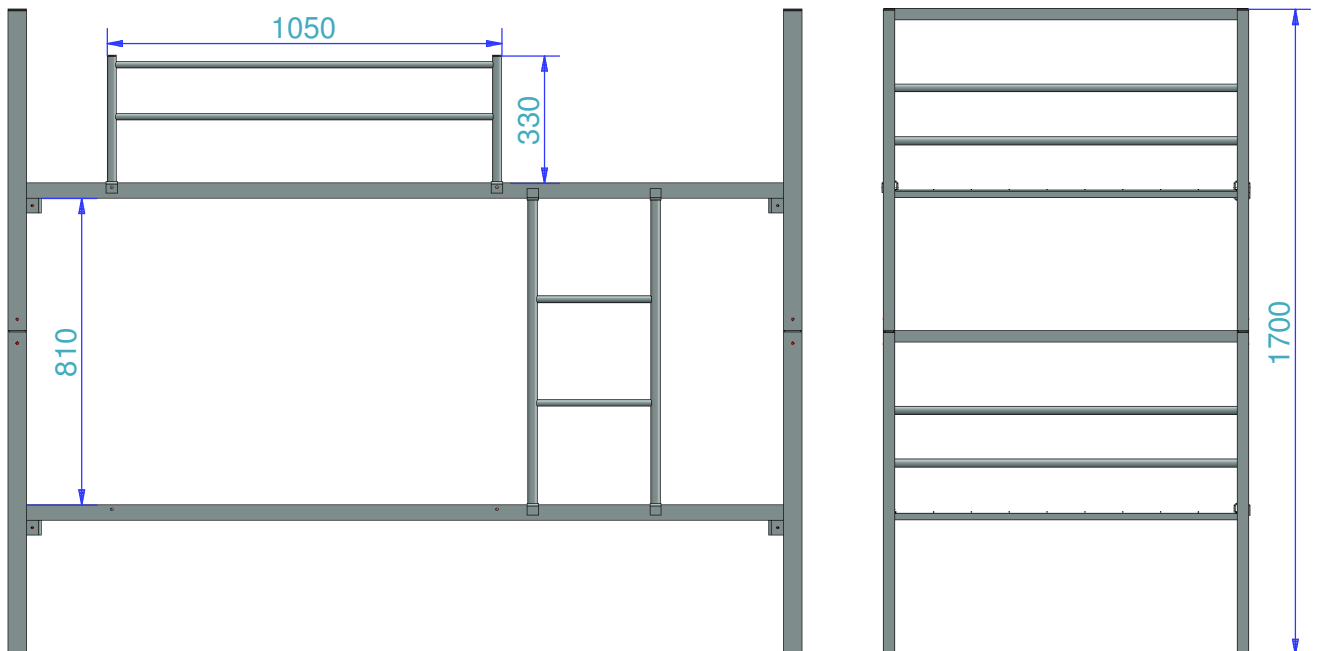
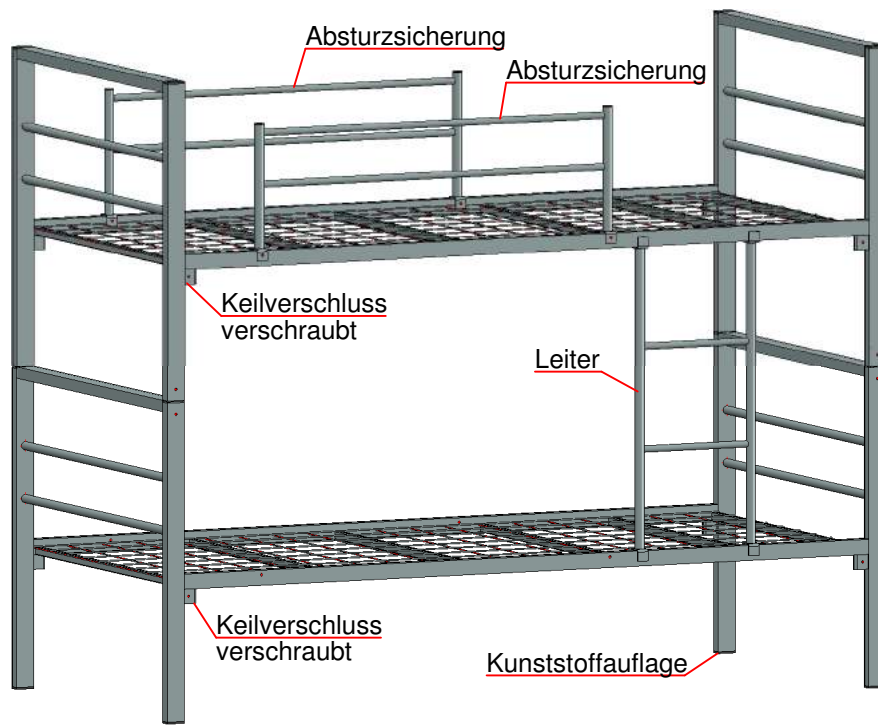

Zubehör  
**Matratze:**  
 Schaumstoffkernmatratze  
 200cm x 90cm 1-lagig  
 oder 2-lagig  
**Anbaunachttisch:**  
 L = 350  
 B = 315  
 H = 123

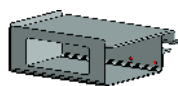

Bezeichnung

**Stockbett E200L**

Maßstab

**1 : 20**

Blatt-Nr.

**2 / 15**

Datum

**20.04.2016**

**RAL 5010**

**RAL 6017**

**RAL 7001**

**RAL 8017**

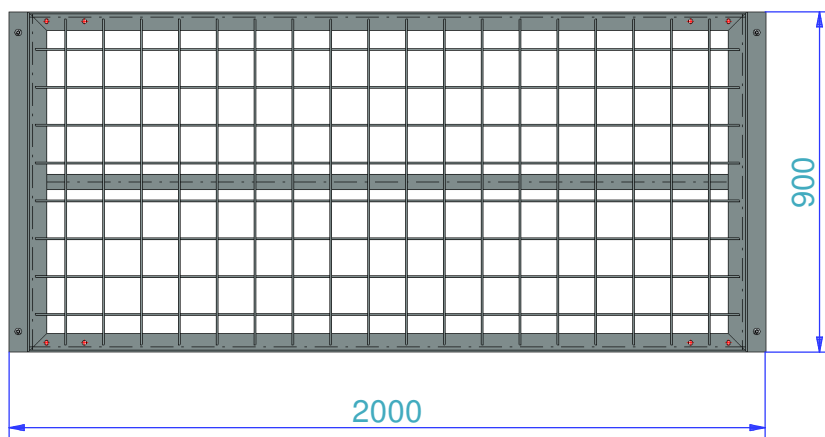
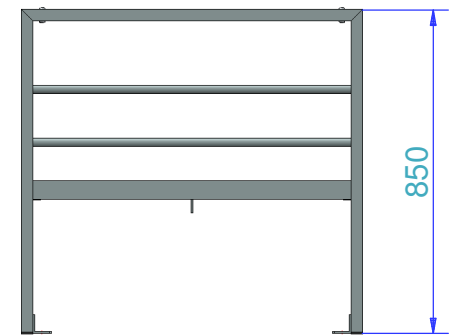
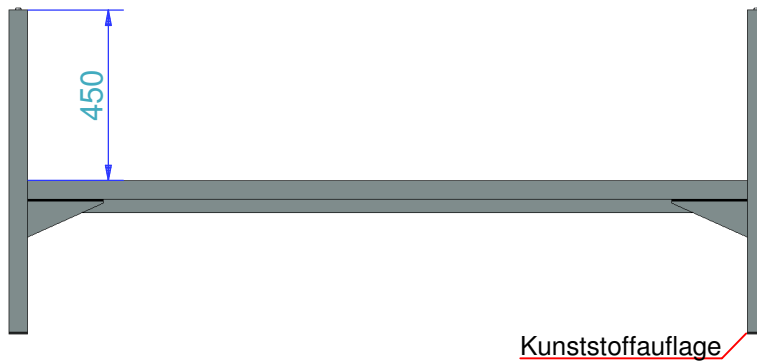
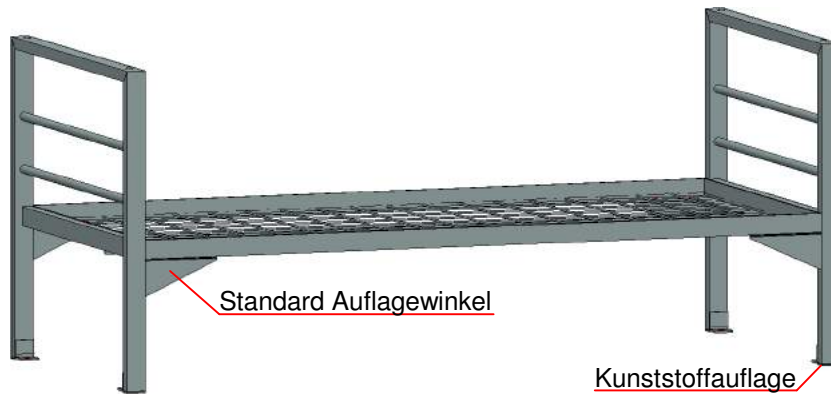

Zubehör  
**Matratze:**  
 Schaumstoffkernmatratze  
 200cm x 90cm 1-lagig  
 oder 2-lagig  
**Anbaunachtisch:**  
 L = 350  
 B = 315  
 H = 123  
**Absturzicherung:**  
 L = 350

**Einsatz mit  
 Rolllattenrost**  
 190cm x 90cm



**Leiter**  
 1285 x  
 360



Bezeichnung

**Einzelbett E190A mit Auflegewinkel stockbar**

Maßstab

**1 : 20**

Blatt-Nr.

**3 / 15**

Datum

**20.04.2016**



**RAL 5010**

**RAL 6017**

**RAL 7001**

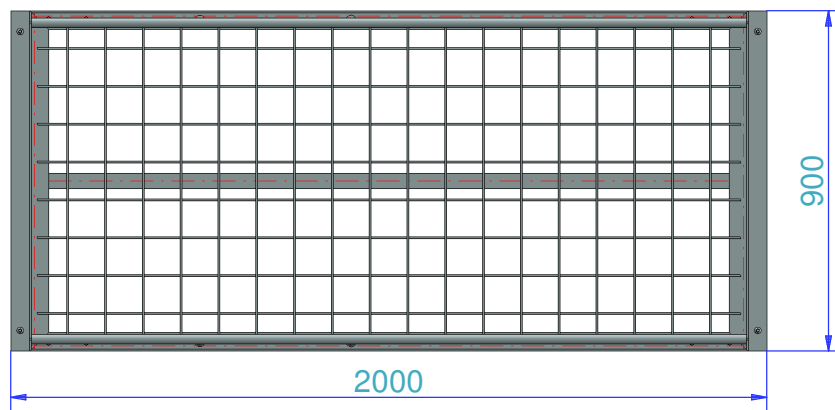
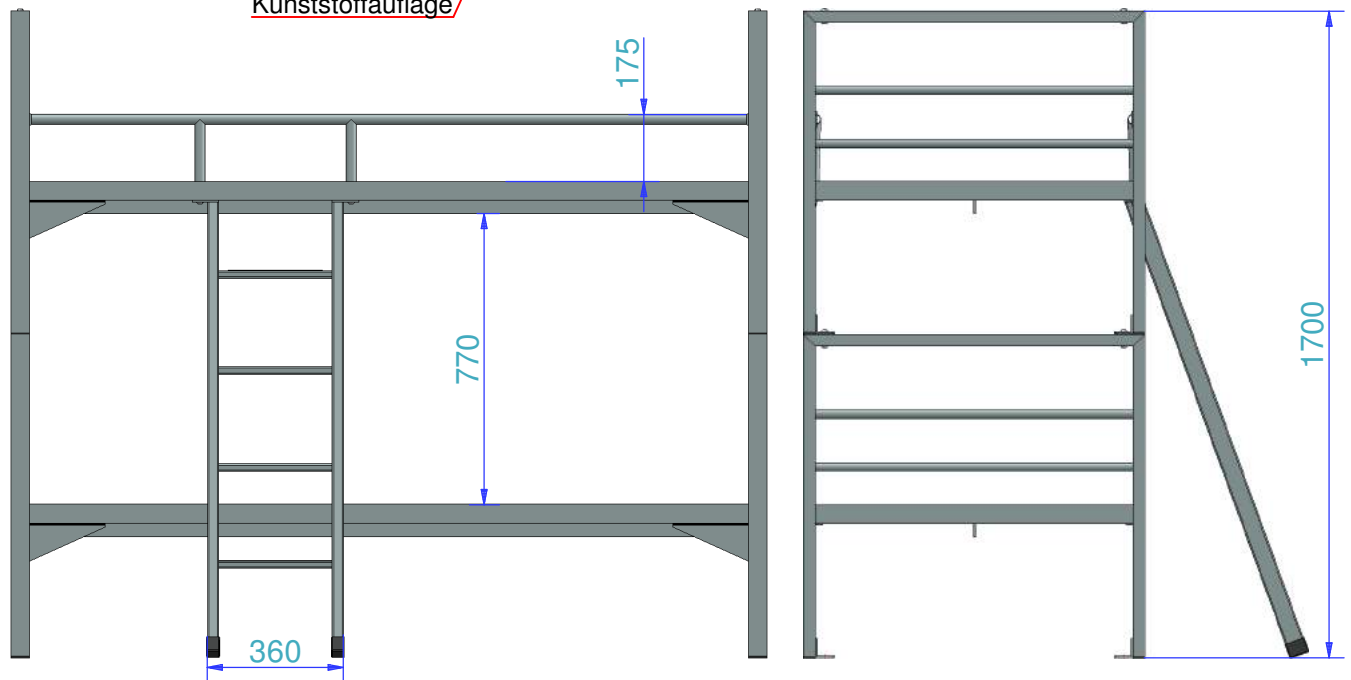
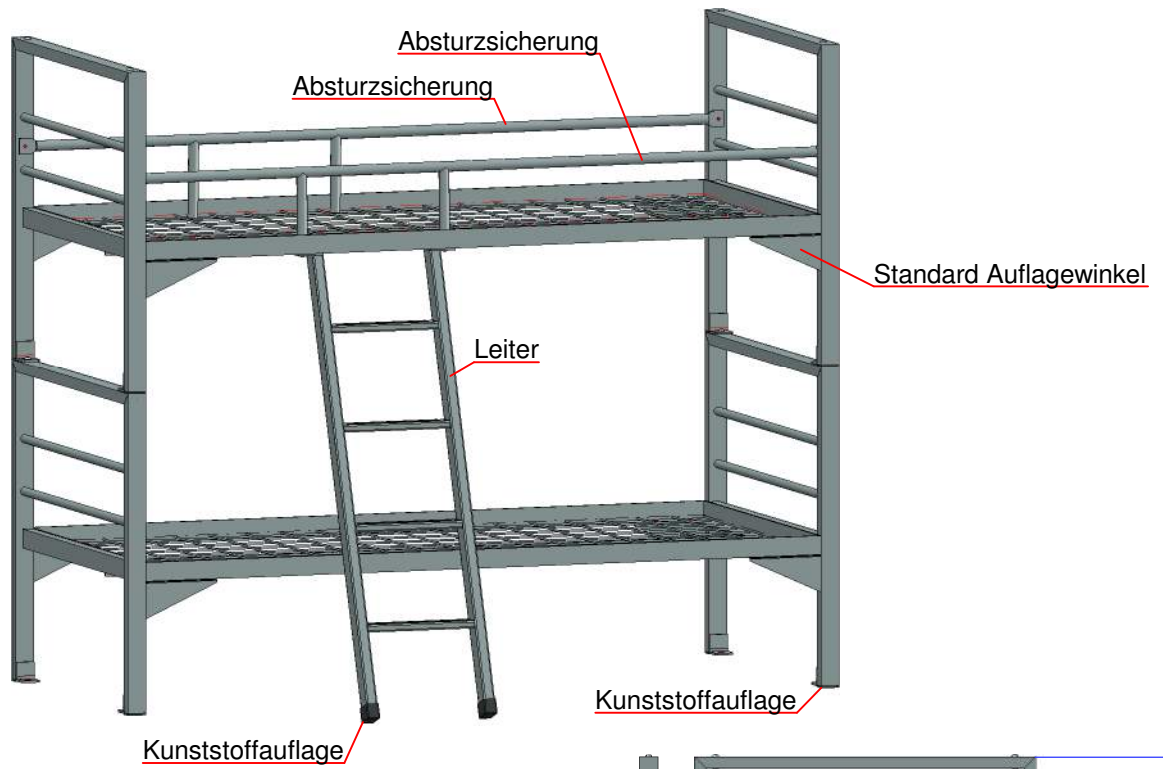
**RAL 8017**

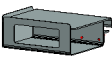

Zubehör  
**Matratze:**  
 Schaumstoffkernmatratze 190cm x 90cm  
 1-lagig oder 2-lagig  
**Anbaunachttisch:**   
 L = 350 / B = 315 / H = 123  
**Einsatz mit Rolllattenrost**  
 190cm x 90cm 

Bezeichnung <b>Stockbett E190A mit Auflegewinkel</b>		
Maßstab <b>1 : 20</b>	Blatt-Nr. <b>4 / 15</b>	Datum <b>20.04.2016</b>
<b>RAL 5010</b>	<b>RAL 6017</b>	<b>RAL 7001</b>
		<b>RAL 8017</b>

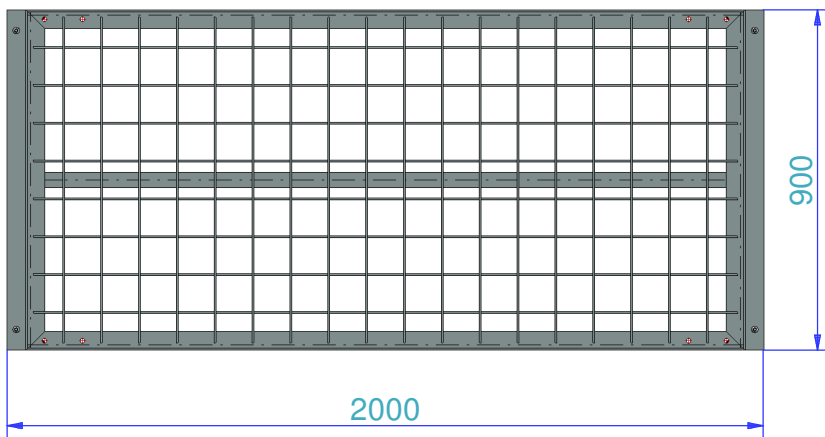
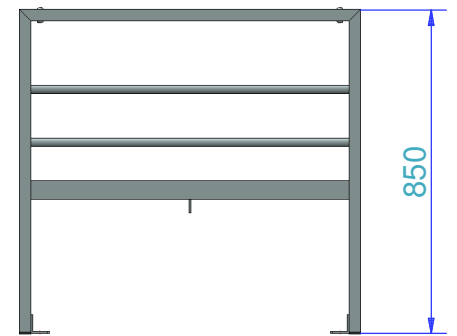
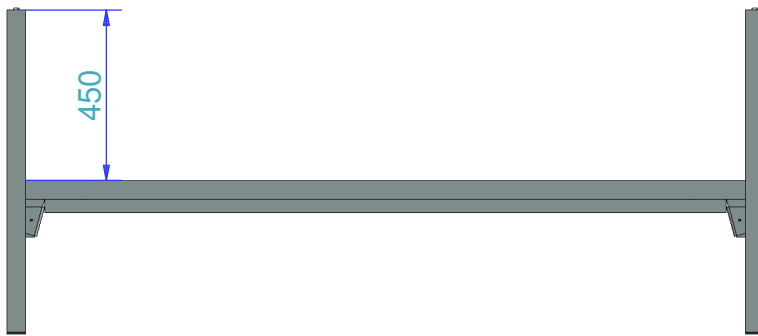
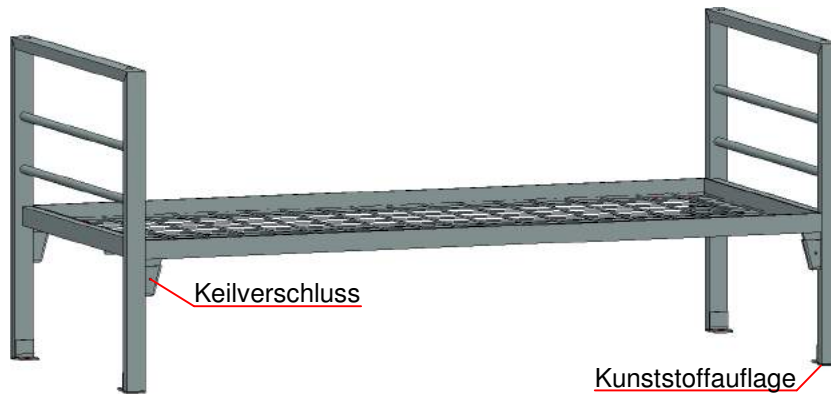

Zubehör

**Matratze:**

Schaumstoffkernmatratze  
200cm x 90cm 1-lagig  
oder 2-lagig

**Anbaunachtisch:**

L = 350  
B = 315  
H = 123

**Absturzicherung:**

L = 350

**Einsatz mit  
Rolllattenrost**

190cm x 90cm

**Leiter**

1285 x  
360

Bezeichnung

**Einzelbett E190A mit Keilverschluss stockbar**

Maßstab

1 : 20

Blatt-Nr.

5 / 15

Datum

20.04.2016



**RAL 5010**

**RAL 6017**

**RAL 7001**

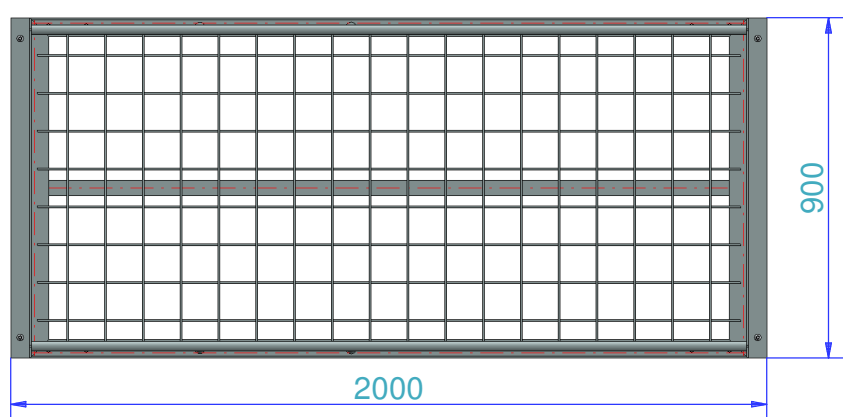
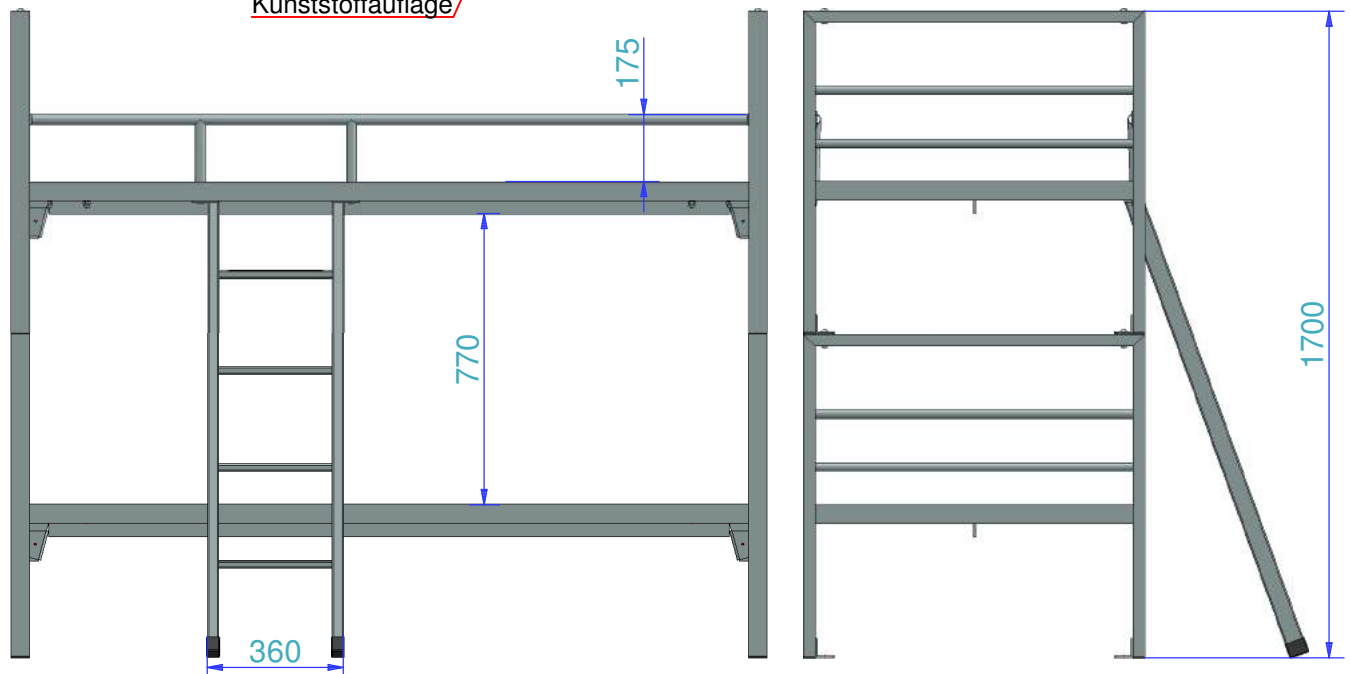
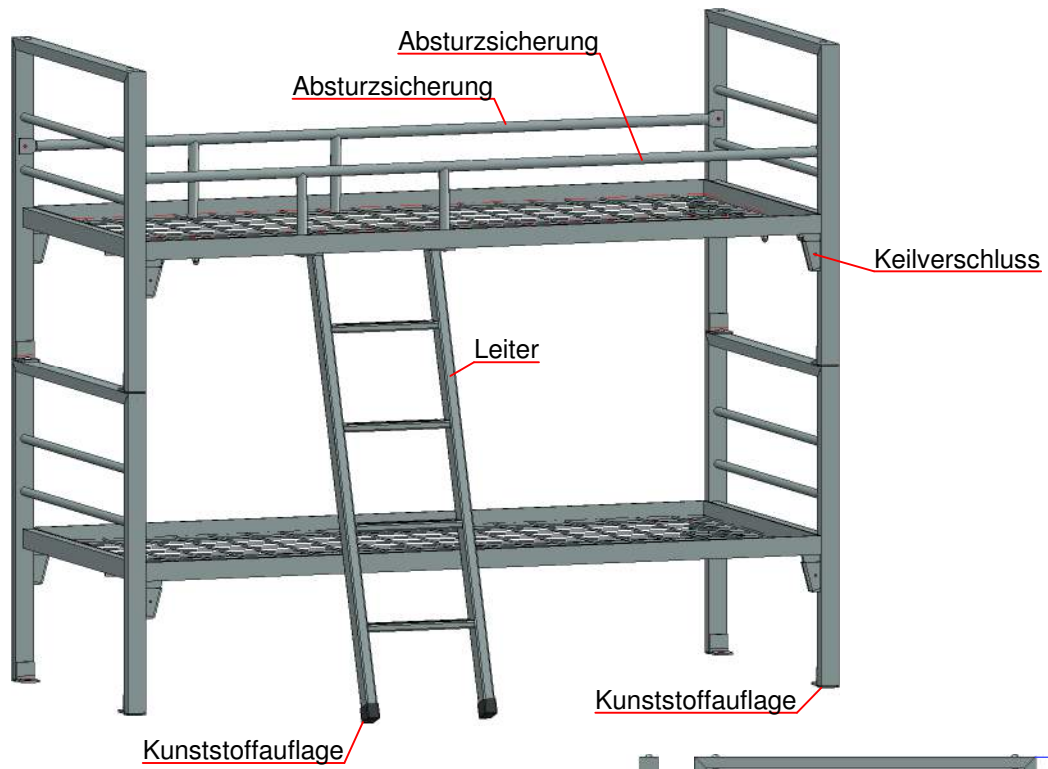
**RAL 8017**

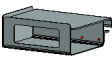

Zubehör  
**Matratze:**  
 Schaumstoffkernmatratze 190cm x 90cm  
 1-lagig oder 2-lagig  
**Anbaunachttisch:**   
 L = 350 / B = 315 / H = 123  
**Einsatz mit Rolllattenrost**  
 190cm x 90cm 

Bezeichnung <b>Stockbett E190A mit Keilverschluss</b>		
Maßstab <b>1 : 20</b>	Blatt-Nr. <b>6 / 15</b>	Datum <b>20.04.2016</b>
<b>RAL 5010</b>	<b>RAL 6017</b>	<b>RAL 7001</b>
		<b>RAL 8017</b>

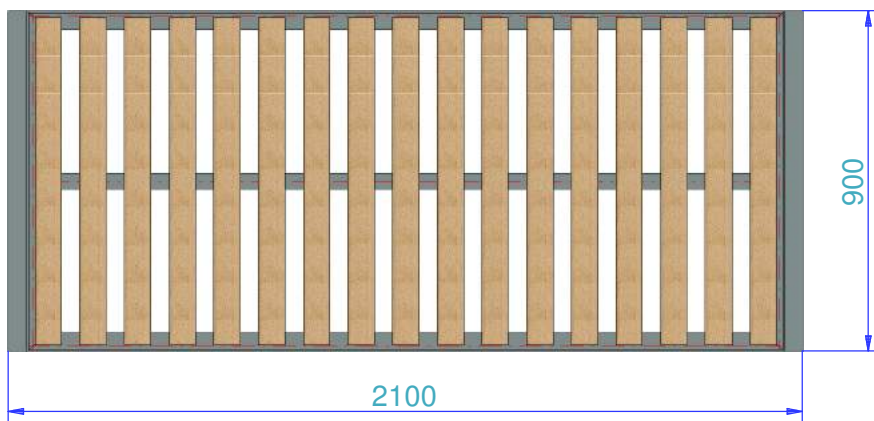
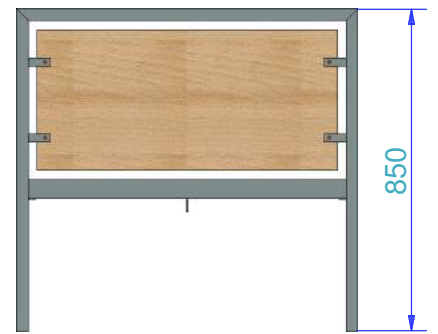
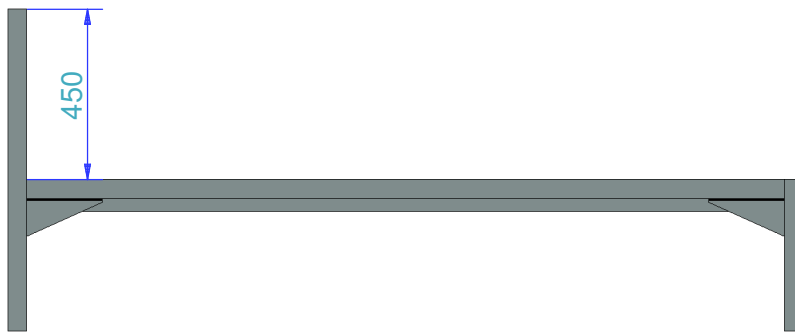
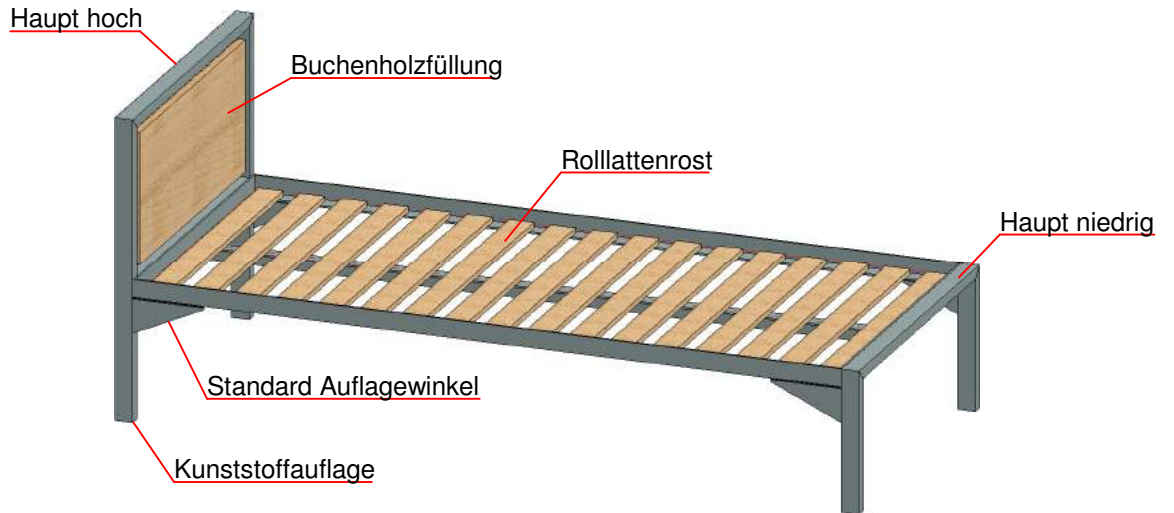

Zubehör  
**Matratze:**  
 Schaumstoffkernmatratze 200cm x 90cm  
 1-lagig oder 2-lagig

**Anbaunachttisch:**  
 L = 350 / B = 315 / H = 123

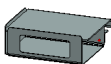

**Einsatz mit Gitterrost**  
 200cm x 90cm

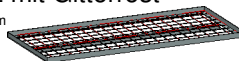

Bezeichnung

**Einzelbett E200J Typ 1**

Maßstab

**1 : 20**

Blatt-Nr.

**7 / 15**

Datum

**20.04.2016**

**RAL 5010**

**RAL 6017**

**RAL 7001**

**RAL 8017**



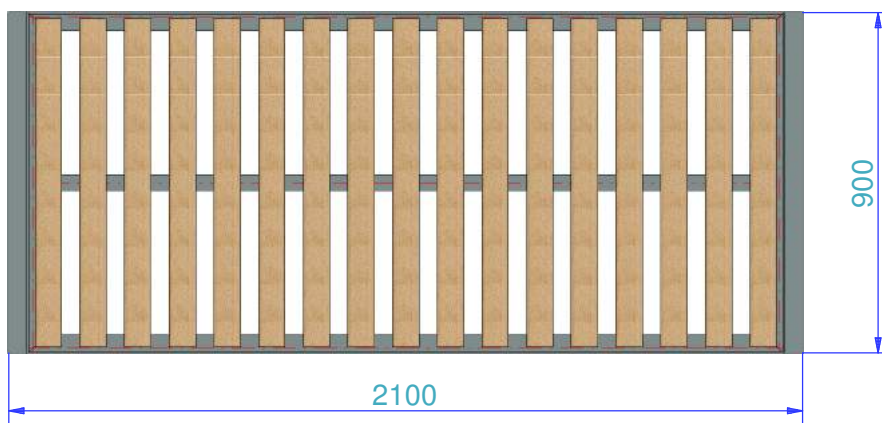
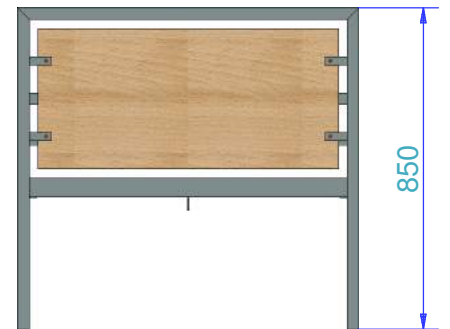
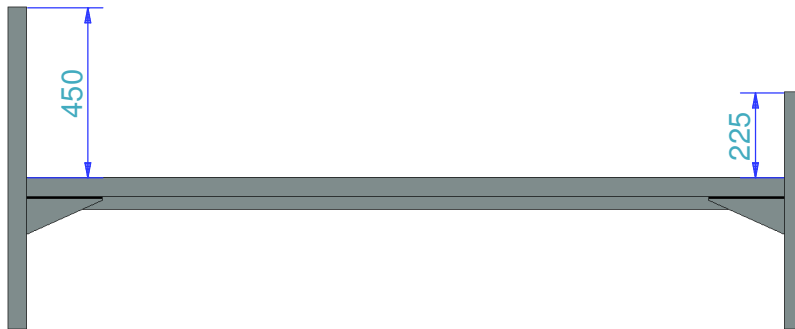
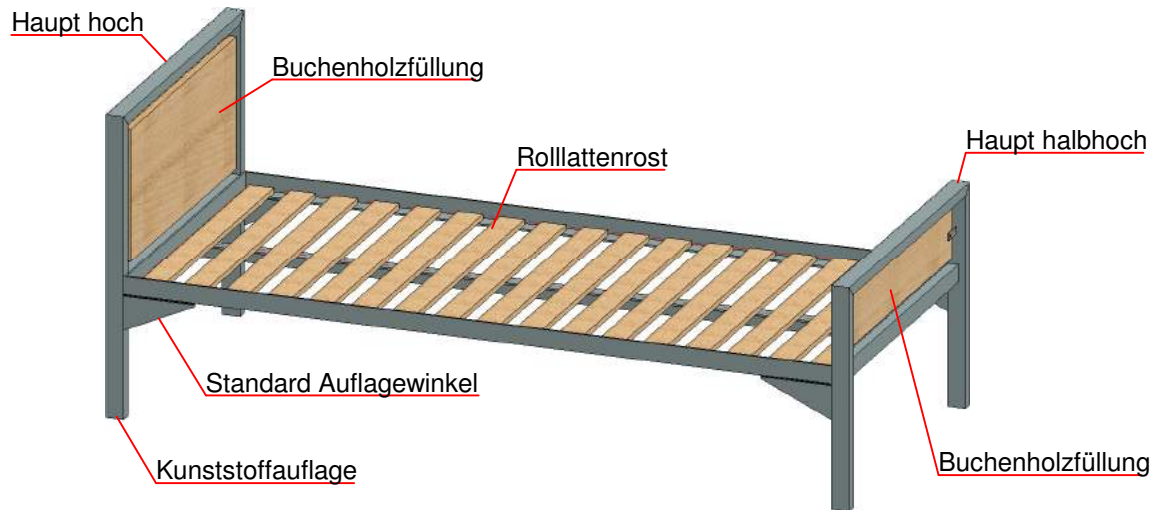

Zubehör  
**Matratze:**  
 Schaumstoffkernmatratze 200cm x 90cm  
 1-lagig oder 2-lagig

**Anbaunachttisch:**   
 L = 350 / B = 315 / H = 123

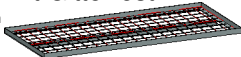
**Einsatz mit Gitterrost**  
 200cm x 90cm 

Bezeichnung  
**Einzelbett E200J Typ 2**

Maßstab	Blatt-Nr.	Datum
1 : 20	8 / 15	20.04.2016

**RAL 5010**

**RAL 6017**

**RAL 7001**

**RAL 8017**

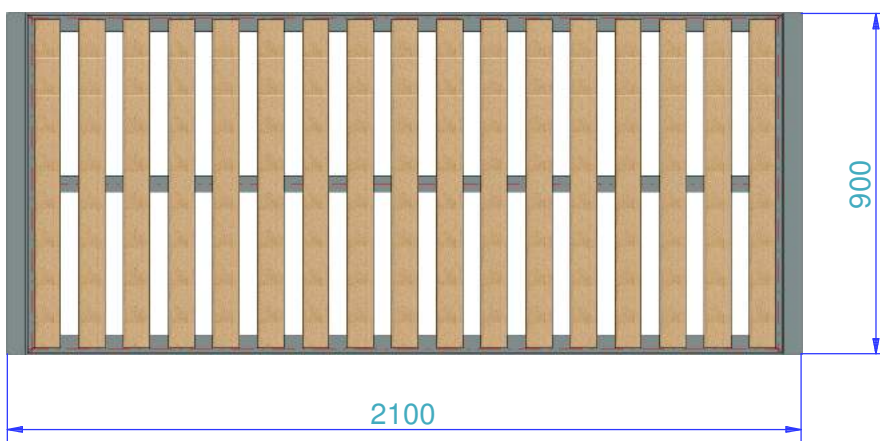
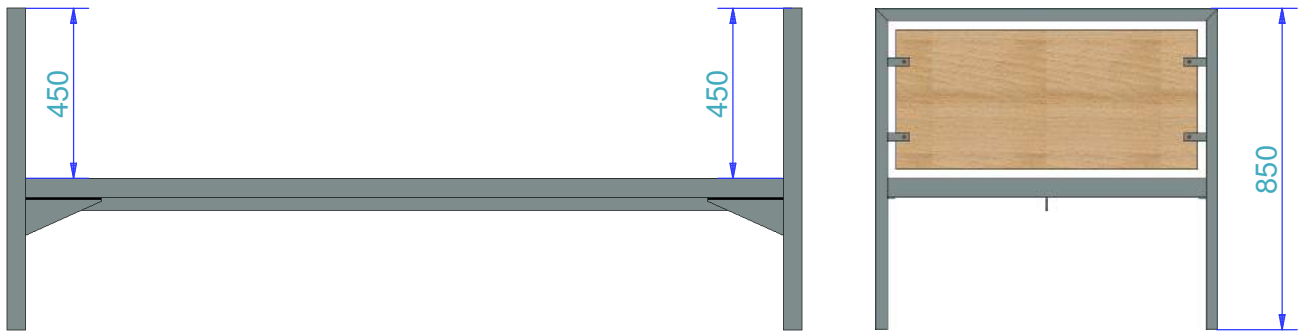
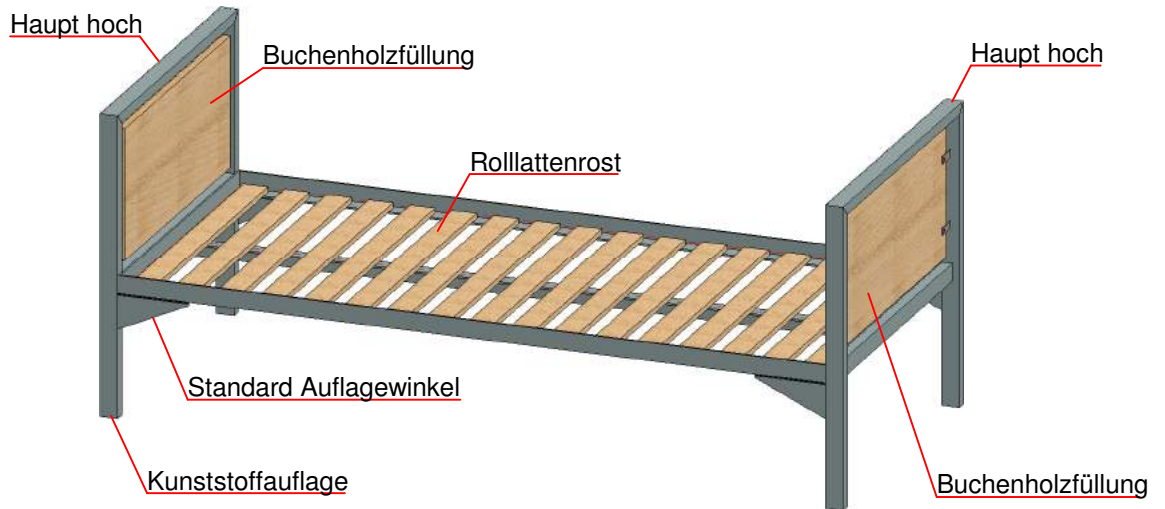

Zubehör  
**Matratze:**  
 Schaumstoffkernmatratze 200cm x 90cm  
 1-lagig oder 2-lagig

**Anbaunachtisch:**  
 L = 350 / B = 315 / H = 123

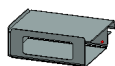

**Einsatz mit Gitterrost**  
 200cm x 90cm

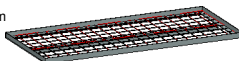

Bezeichnung

**Einzelbett E200J Typ 3**

Maßstab

**1 : 20**

Blatt-Nr.

**9 / 15**

Datum

**20.04.2016**

**RAL 5010**

**RAL 6017**

**RAL 7001**

**RAL 8017**

### Haupt hoch zu Bett E200J



### Haupt halbhoch zu Bett E200J

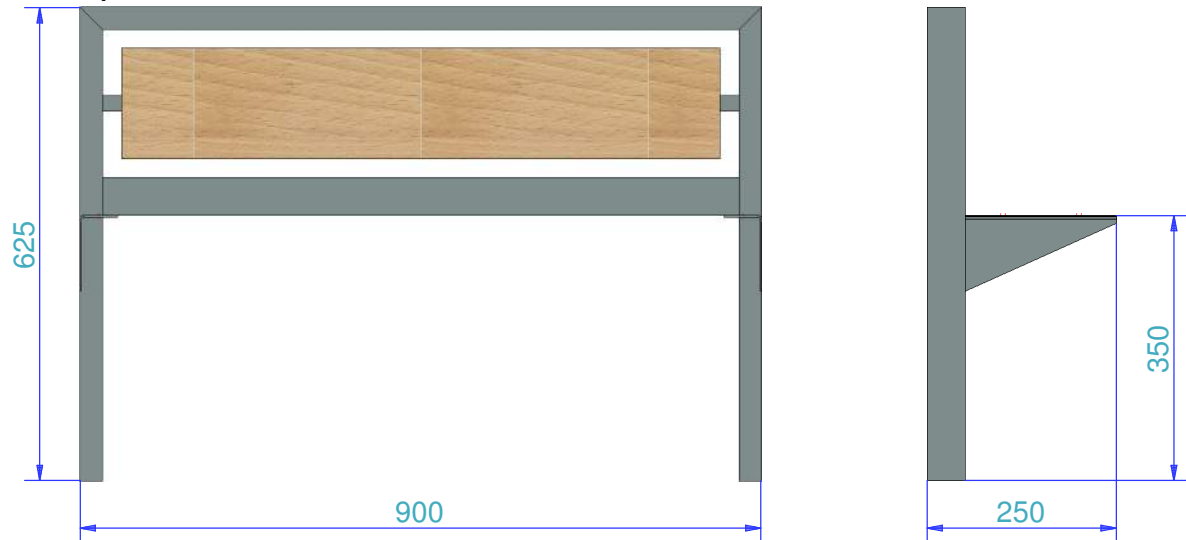

### Haupt niedrig zu Bett E200J

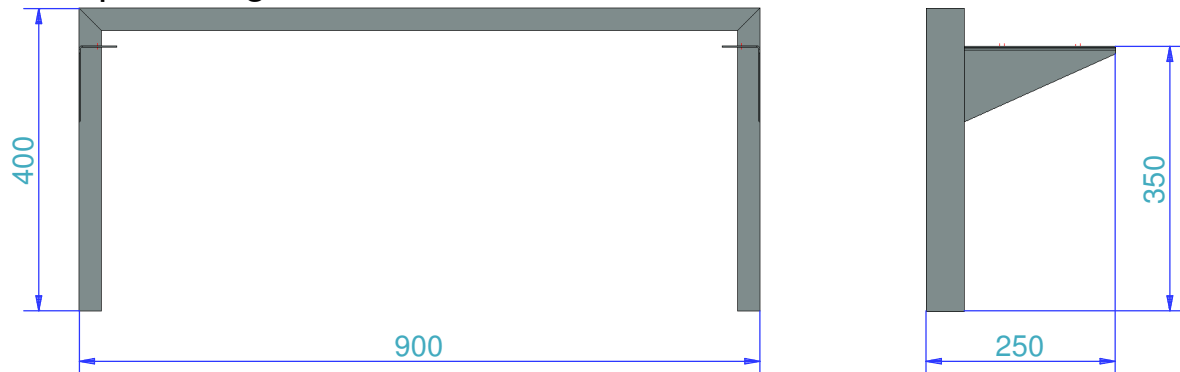

www.riel-metallbau.at

Zubehör

Bezeichnung

Häupter zu Bett E200J

Maßstab

1 : 20

Blatt-Nr.

10 / 15

Datum

20.04.2016

RAL 5010

RAL 6017

RAL 7001

RAL 8017

Einsatz mit Rolllattenrost zu Bett E200J

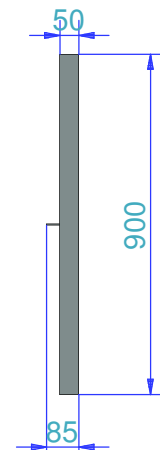
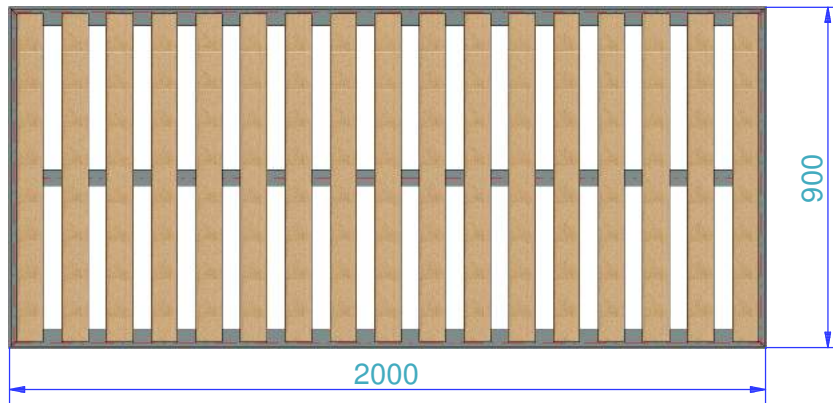

Einsatz mit Gitterrost zu Bett E200J

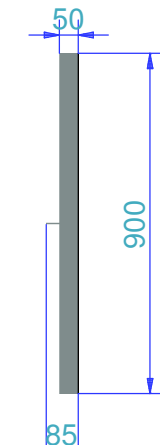
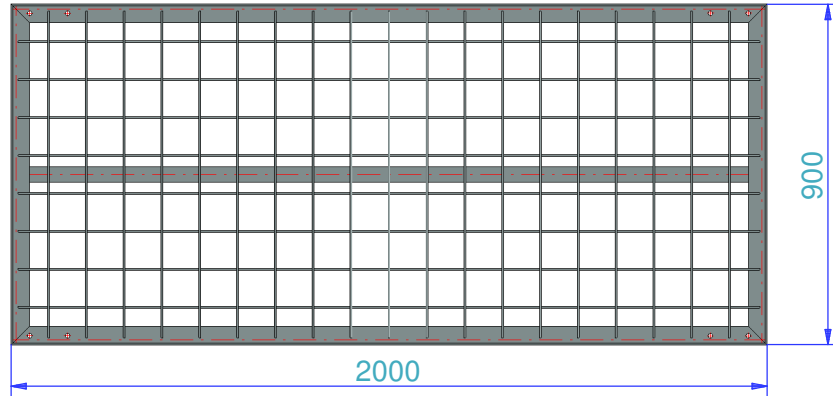

Einsatz mit Rolllattenrost zu Bett E190A

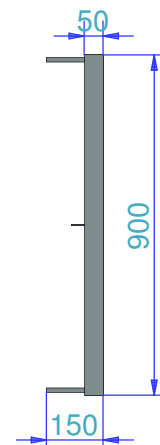
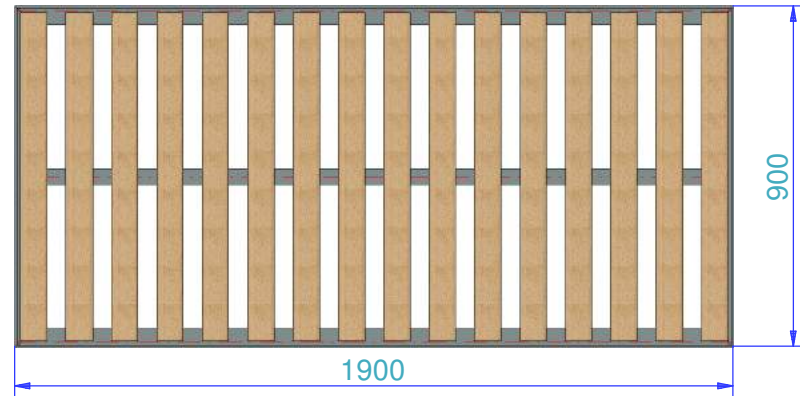

Einsatz mit Gitterrost zu Bett E190A

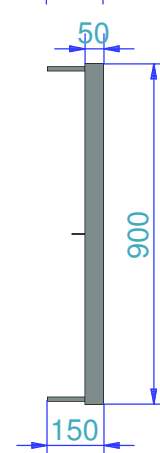
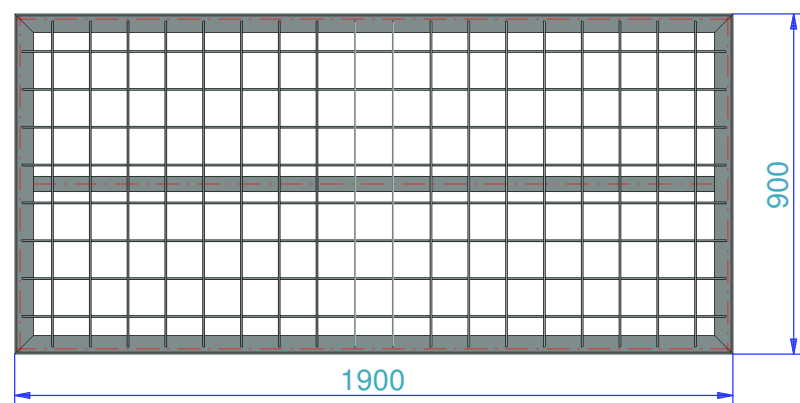

www.riel-metallbau.at

Zubehör

Bezeichnung

Betteinsätze

Maßstab

1 : 20

Blatt-Nr.

11 / 15

Datum

20.04.2016

RAL 5010

RAL 6017

RAL 7001

RAL 8017

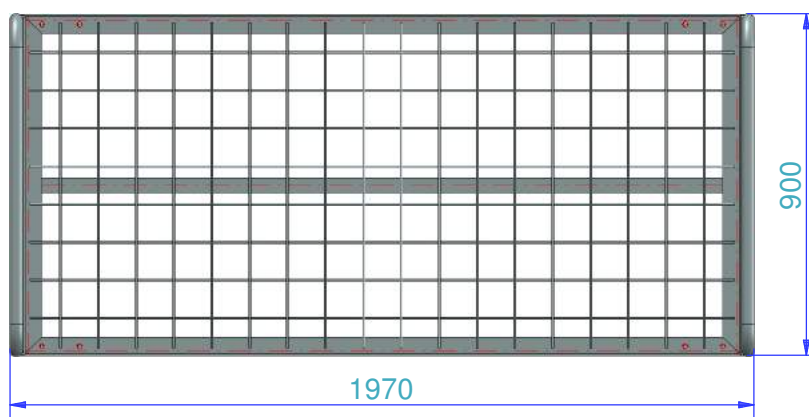
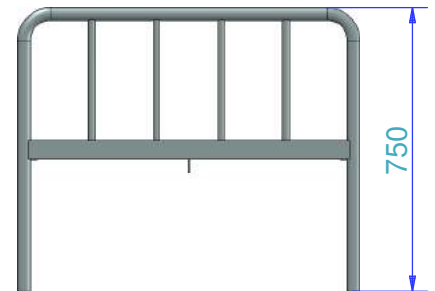
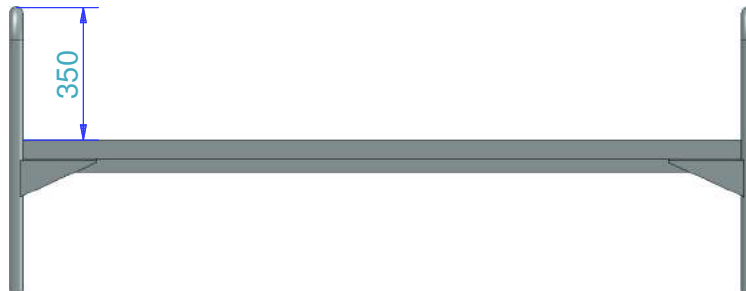
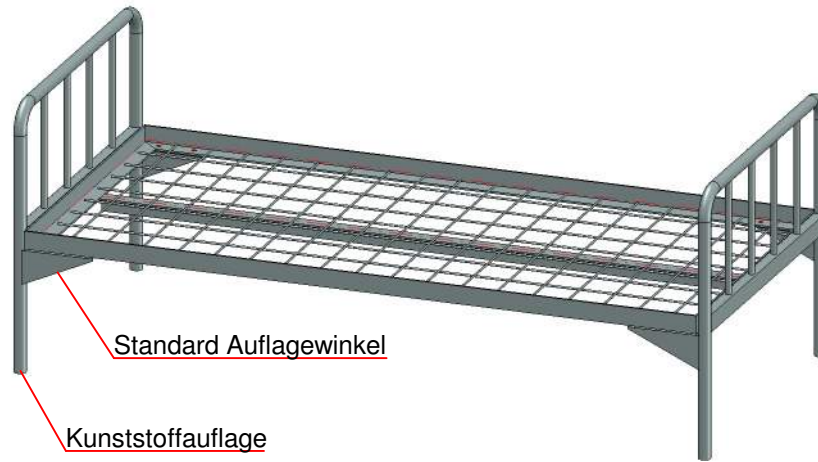

Zubehör

**Matratze**

Schaumstoffkernmatratze  
190cm x 90cm 1-lagig  
oder 2-lagig

**Anbaunachttisch:**

L = 350  
B = 315  
H = 123

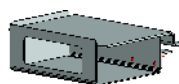

Bezeichnung

**Einzelbett E190RR mit Auflegewinkel**

Maßstab

1 : 20

Blatt-Nr.

12 / 15

Datum

20.04.2016

RAL 5010

RAL 6017

RAL 7001

RAL 8017

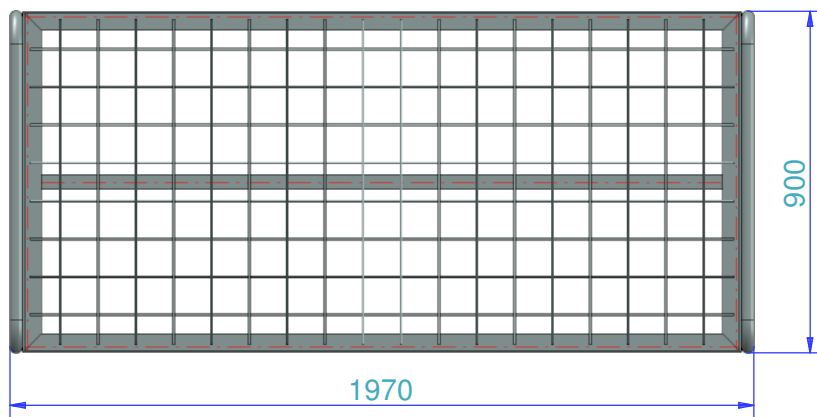
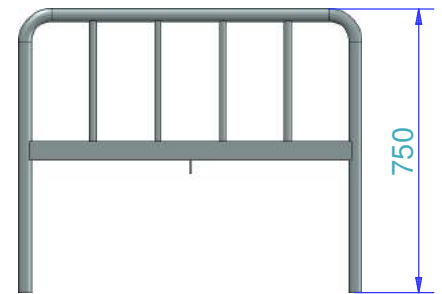
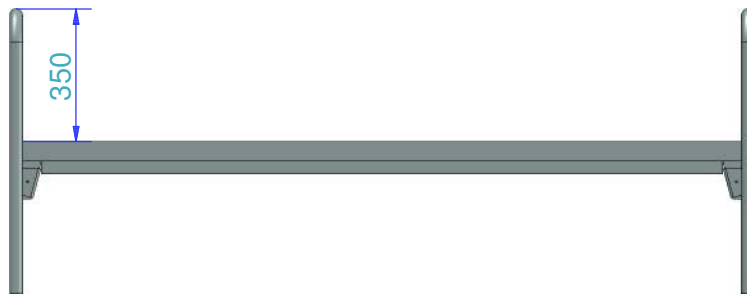
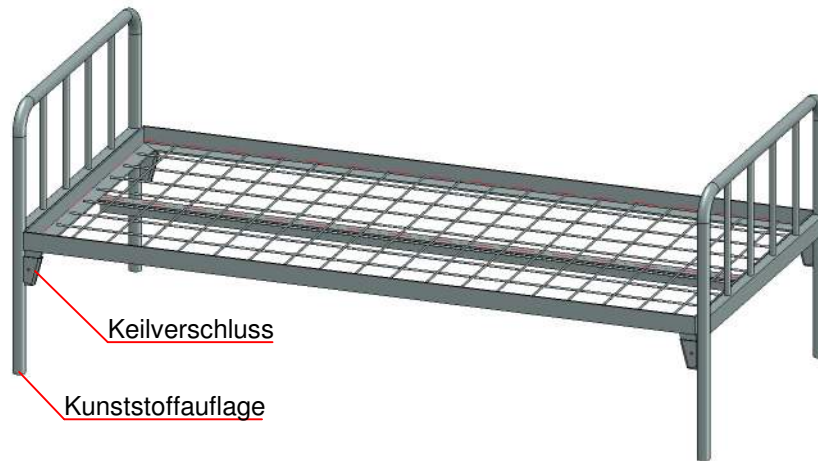

Zubehör

**Matratze:**  
Schaumstoffkernmatratze  
190cm x 90cm 1-lagig  
oder 2-lagig

**Anbaunachttisch:**

L = 350  
B = 315  
H = 123

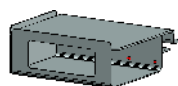

Bezeichnung

**Einzelbett E190RR mit Keilverschluss**

Maßstab

1 : 20

Blatt-Nr.

13 / 15

Datum

20.04.2016

**RAL 5010**

**RAL 6017**

**RAL 7001**

**RAL 8017**



Kunststoffauflage

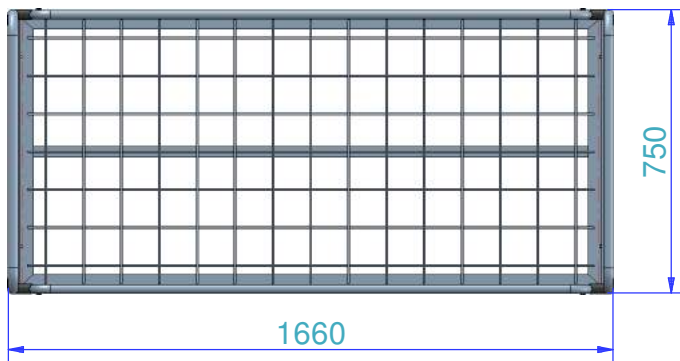
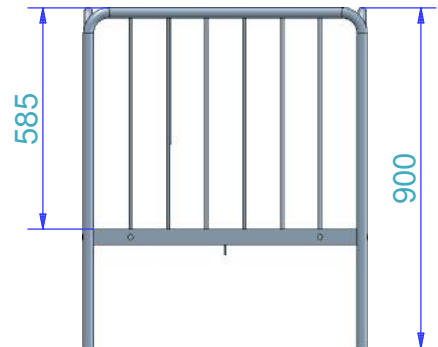
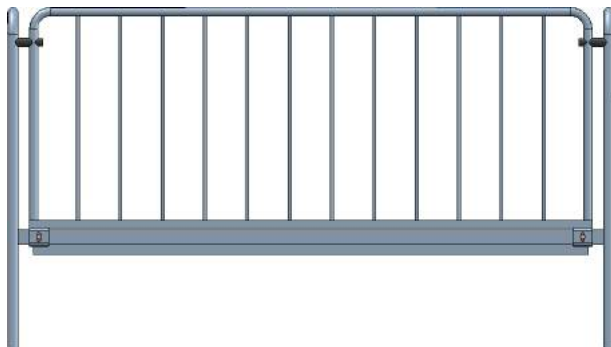

www.riel-metallbau.at

Zubehör

**Matratze:**  
Schaumstoffkernmatratze  
160cm x 70cm 1-lagig

Bezeichnung

**Kinderbett 166 x 75**

Maßstab

1 : 20

Blatt-Nr.

14 / 15

Datum

20.04.2016

RAL 5010

RAL 6017

RAL 7001

RAL 8017

RAL 9016

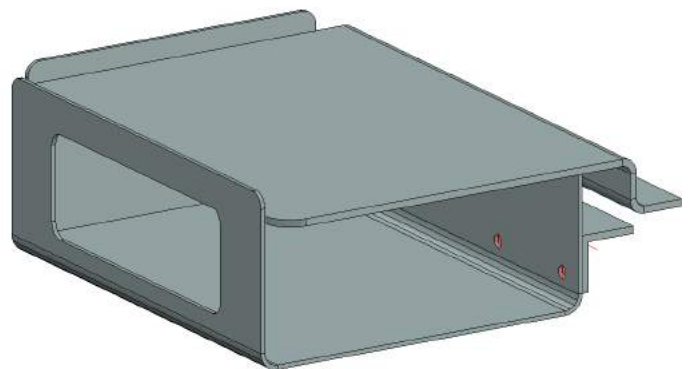
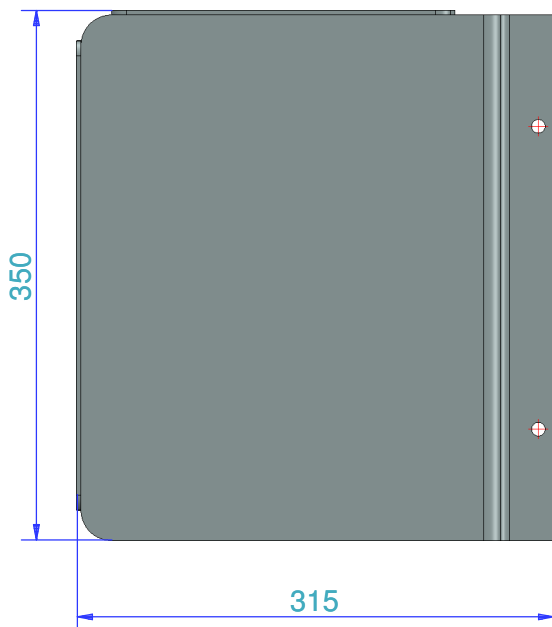
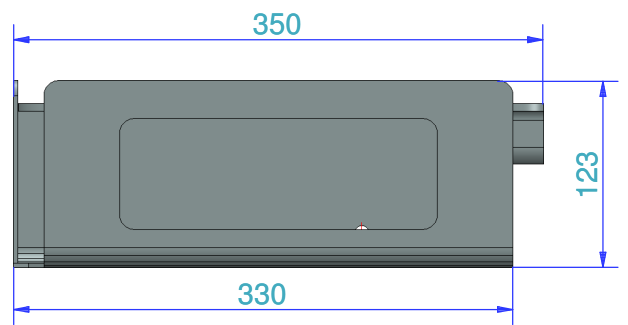
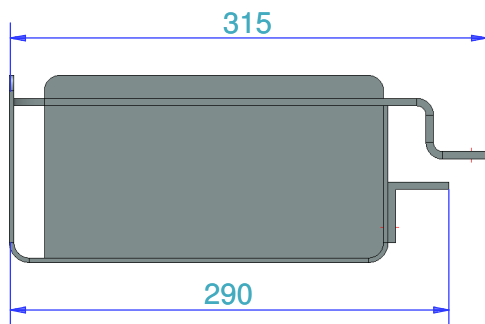
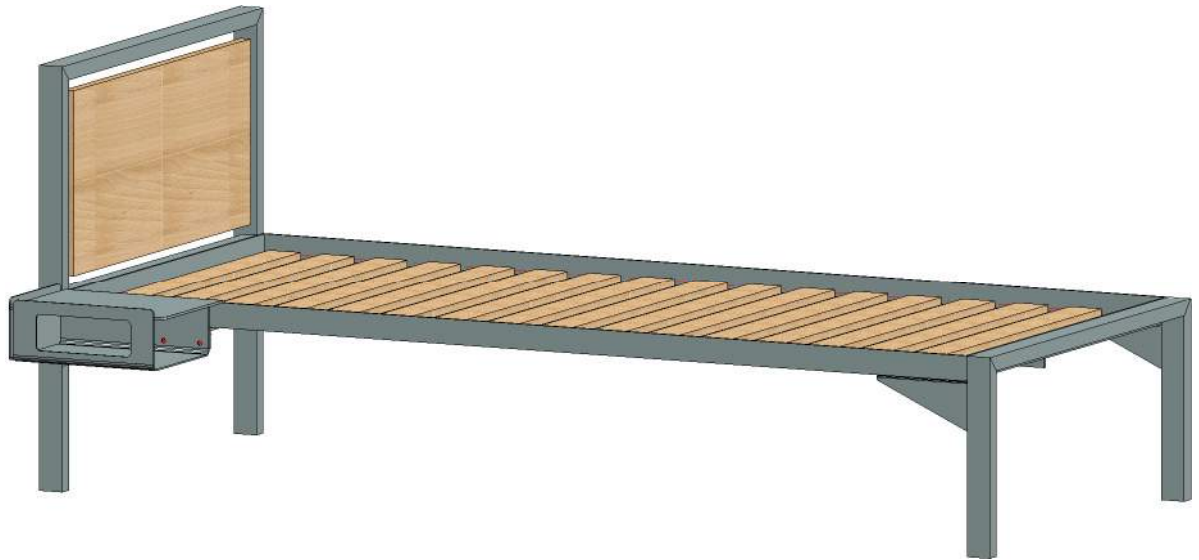

Zubehör

Bezeichnung

Anbaunachttisch

Maßstab

1 : 5

Blatt-Nr.

15 / 15

Datum

20.04.2016

RAL 5010

RAL 6017

RAL 7001

RAL 8017